

### 13. Oracle database software instance management.

The Oracle database server consists of an Oracle instance and an Oracle database. The Oracle instance includes memory and process areas.

The Oracle database includes data files, a control file, and log files (fig. 13.1.).

It is necessary to start the instance so that users have access to the database. When the instance is started, an initialization parameter file is read to configure the instance; memory areas are allocated and processes are started.

After starting the instance and opening the database, users can access the database.

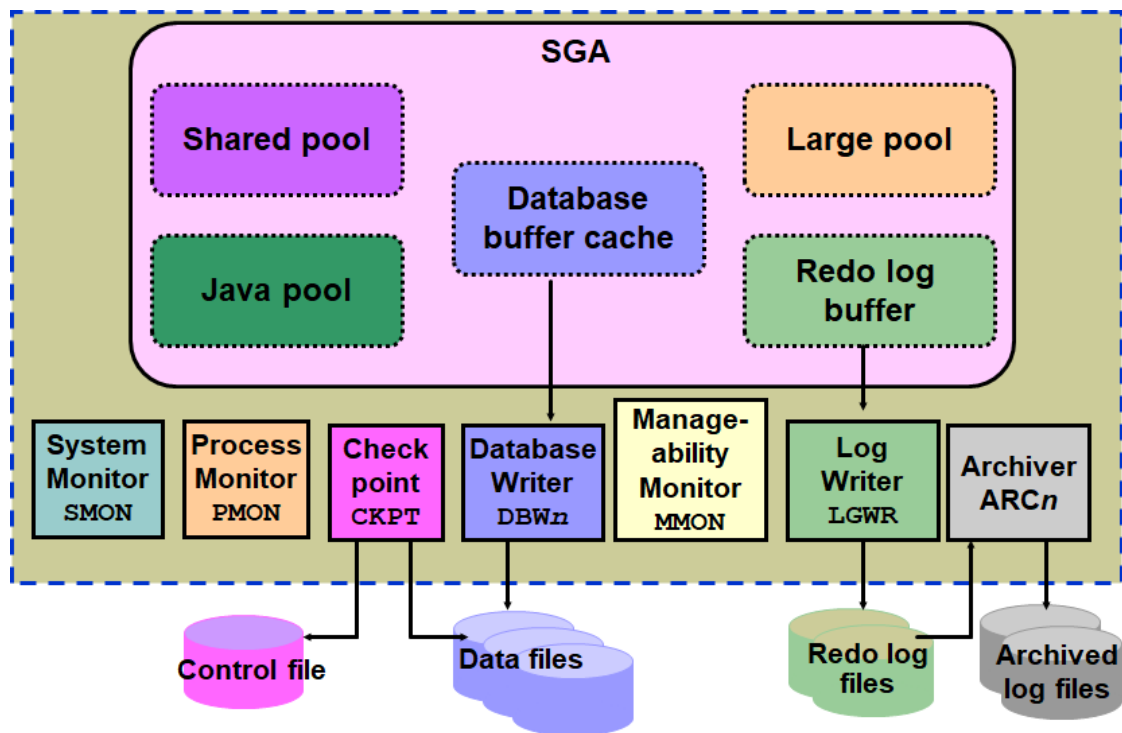
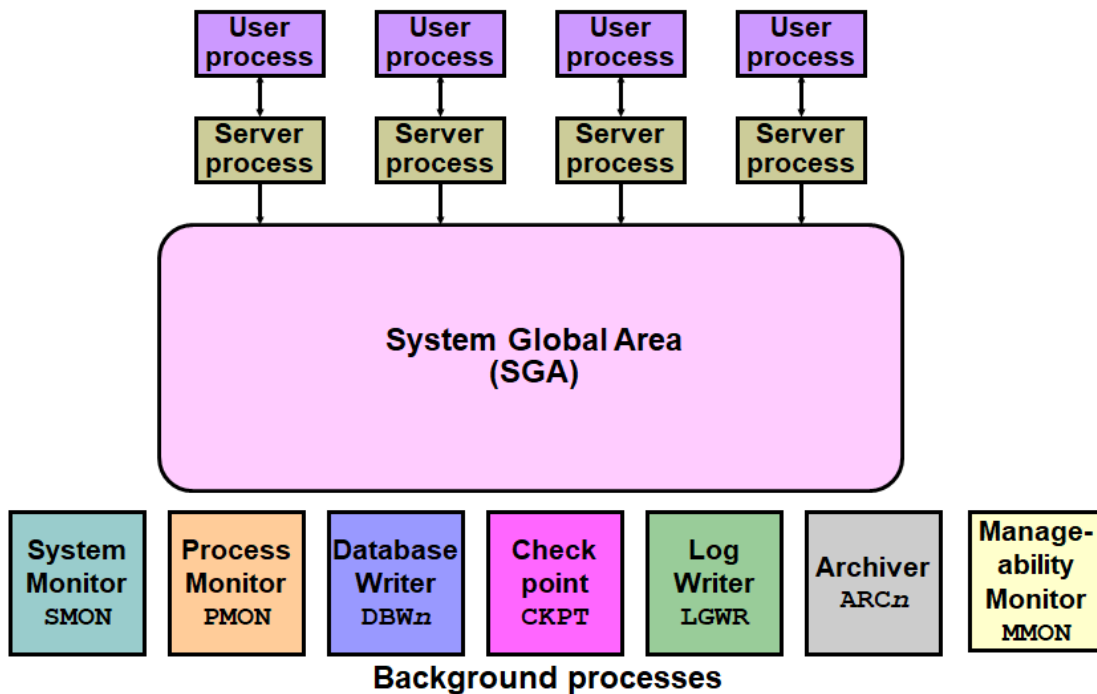

Fig. 13.1. Oracle instance management.

# Oracle Processes



*Fig. 13.2. Oracle processes.*

## 1.1. Oracle processes.

When an Oracle application or tool, such as Enterprise Manager, is called, the Oracle server creates a user process to run the user application. The Oracle server creates server processes to process requests for user processes that are connected to the instance.

The Oracle server also creates a set of background processes for the instance, which interacts with each other and with the operating system for managing memory structures, performing I / O for writing data to disk and common work (fig. 13.2.).

There are many background processes. Depending on the functions used in the database, not all background processes may be present. The most common background processes are:

- System Monitor (SMON): Performs instance recovery when the instance is started after a failure.
- Process Monitor (PMON): Recovers the process when a user process fails by clearing the cache and freeing up resources that the process uses.

- Database Writer (DBWn): Saves modified blocks of the database cache to disk files.

- Checkpoint (CKPT): Alerts DBWn to checkpoints and updates all data files and database control files to indicate the latest checkpoint. When a checkpoint appears, any changes made to transactions are saved to disk data files.

- Log Writer (LGWR): Records repeated entries in the disc log

- Archiver (ARCn): Copies duplicate log files to archive storage when log files are full or when log switching occurs. The backup process is only available when the database is in ARCHIVELOG mode and automatic backup is enabled.

- Management Monitor (MMON): Performs various basic tasks related to manageability such as:

- letters of notification when an indicator exceeds its threshold;

- takes pictures by reproducing additional processes;

- capture statistical values for SQL objects that have recently changed.

## **1.2. Oracle memory structures.**

The main memory structures associated with the Oracle instance include (fig. 13.3.):

- System Global Area (SGA): Shared by all server and background processes

- Global Program Area (PGA): Private to each server and background process. There is one PGA for each process.

### Global System Area (SGA)

The System Global Zone (SGA) is a shared memory area that contains data and control information about an instance.

The SGA includes the following data structures:

- Database Cache Buffer: Contains copies of data blocks extracted from the database.

The data stored in the database must be read from the disk and stored in memory before it can be viewed or modified.

- Rewrite buffer: Buffers repeat information (used for recovery, for example) until it can be saved in the physical rewrite files stored on the disc.

- Shared pool: Caches SQL code that can be shared between users.

- Large pool: Optional area used to buffer I / O requests and Recovery Manager (RMAN) backup buffers.

- Java pool: Used for all session-specific Java code and data in the Java Virtual Machine (JVM).

## Oracle Memory Structures

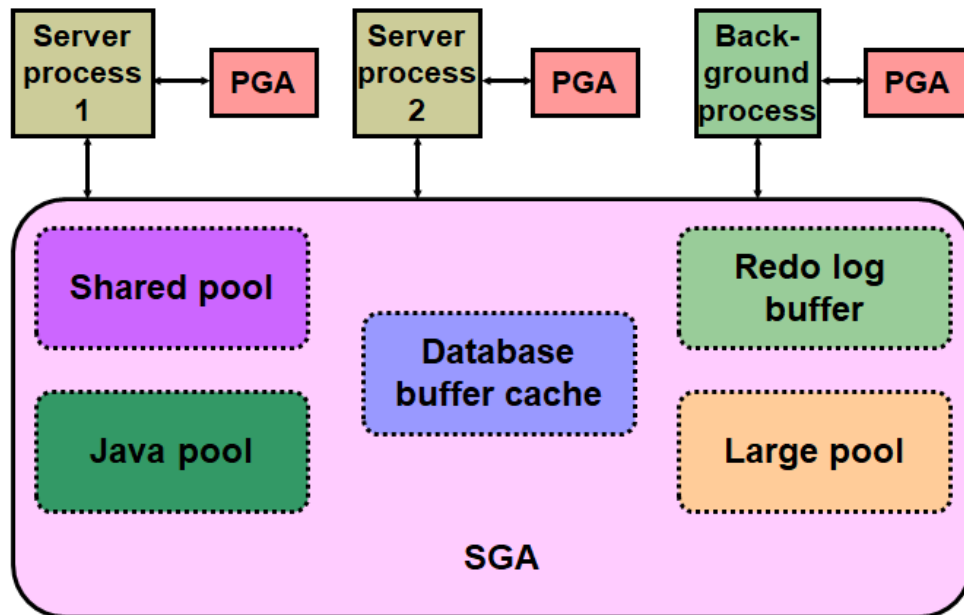

*Fig. 13.3. Oracle data structures.*

When the instance is started using Enterprise Manager or SQL \* Plus, the memory allocated for SGA is displayed.

With the dynamic SGA infrastructure, the dimensions of the database buffer, shared pool, large pool, and Java pool can be changed without excluding the instance.

Oracle Database 11g includes an automatic memory management feature. This feature allows the Oracle Database server to fully automatically manage the SGA memory and PGA memory of the instance.

### Global Program Area (PGA).

The Global Program Area (PGA) is a memory region that contains data and control information for each server process. A server process is a process or thread of an operating system that handles client requests. Each server process has its own private PGA, which is created when the server process starts. Access to the private PGA is exclusive to this server and can only be read and written by it.

### **1.3. Starting an instance and opening a database.**

To make the database available for use, the following steps are performed:

1. The instance is started: the SGA is allocated and background processes are started.
2. Mount the database: The control file is read.

3. The database opens: The database is accessible.

- All three steps can be performed by selecting Startup in Enterprise Manager (fig. 13.4.).

These steps are performed using the Enterprise Manager or the SQL \* Plus STARTUP command. When the instance is started, the server parameter file (SPFILE) or the initialization parameter file is read to determine the values of the initialization parameters. The SGA is then distributed and the background processes are started.

When the database is installed, the control file is read and the data files are checked for compliance. Certain administrative functions and recovery operations can be performed during the installation phase.

When the database is opened, the redo files and data files are read and opened. In this state, the database is accessible to users.

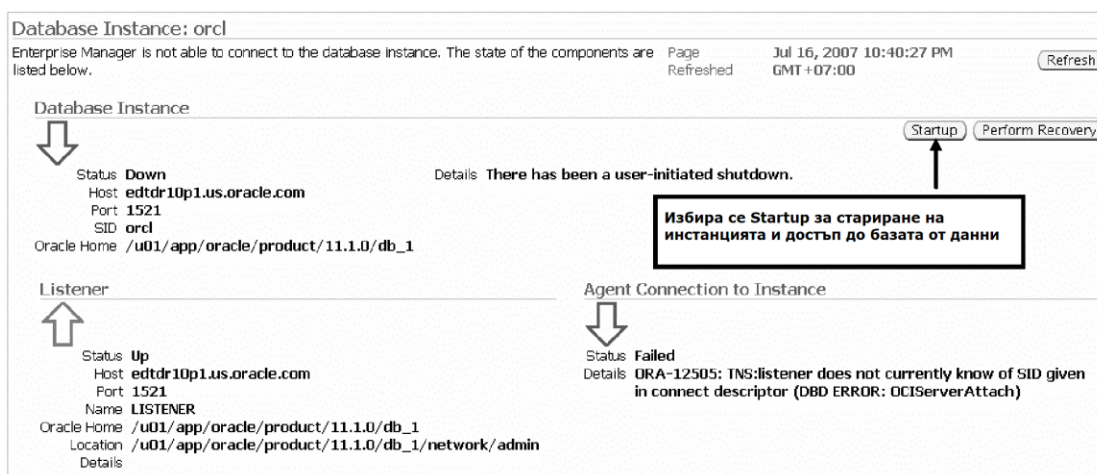

Fig. 13.4. Starting the instance.

#### 1.4. Disable an Oracle database instance.

Selecting "Shutdown" on the database home page turns off the instance. If the "Advanced Options" button is then selected, the switch-off mode can be selected: Normal, Transactional, Immediate or Interrupt (fig. 13.5.).

Shutdown modes progressively adjust to current activity in this order:

- ABORT: Performs the least work before turning off. Because this mode requires recovery before startup, it is used only when necessary. It is usually used when no other form of shutdown is working, when there are problems starting the instance, or when it needs to be shut down immediately due to an upcoming situation, such as a power outage notification within seconds.

- IMMEDIATE: is the most commonly used option. Outstanding transactions are returned.
- TRANSACTIONAL: Allows you to complete transactions.
- NORMAL: Waiting for sessions to end.



*Fig. 13.5. Options to exclude the instance..*

### 1.5. View and change initialization parameters.

When the instance is started, the initialization parameter file is read. There are two types of parameter files:

- Server parameter file: This is the preferred type of initialization parameter file. This is a binary file that can be written and read from the database server and does not need to be edited manually. It resides on the server on which Oracle runs and is persistent at shutdown and startup. This is often called SPFILE.

- Text initialization parameter file: This type of initialization parameter file can be read by the database server but not written by the server. The settings of the initialization parameter must be changed manually using a text editor so that they are constant when shutting down and starting.

With Enterprise Manager, you can view or change initialization parameters:

1. Select the Server connection to access the server properties page.

2. Select "Initialization Parameters" - Initialization Parameters in the Database Configuration section to open the Initialization Parameters page (fig. 13.6.).

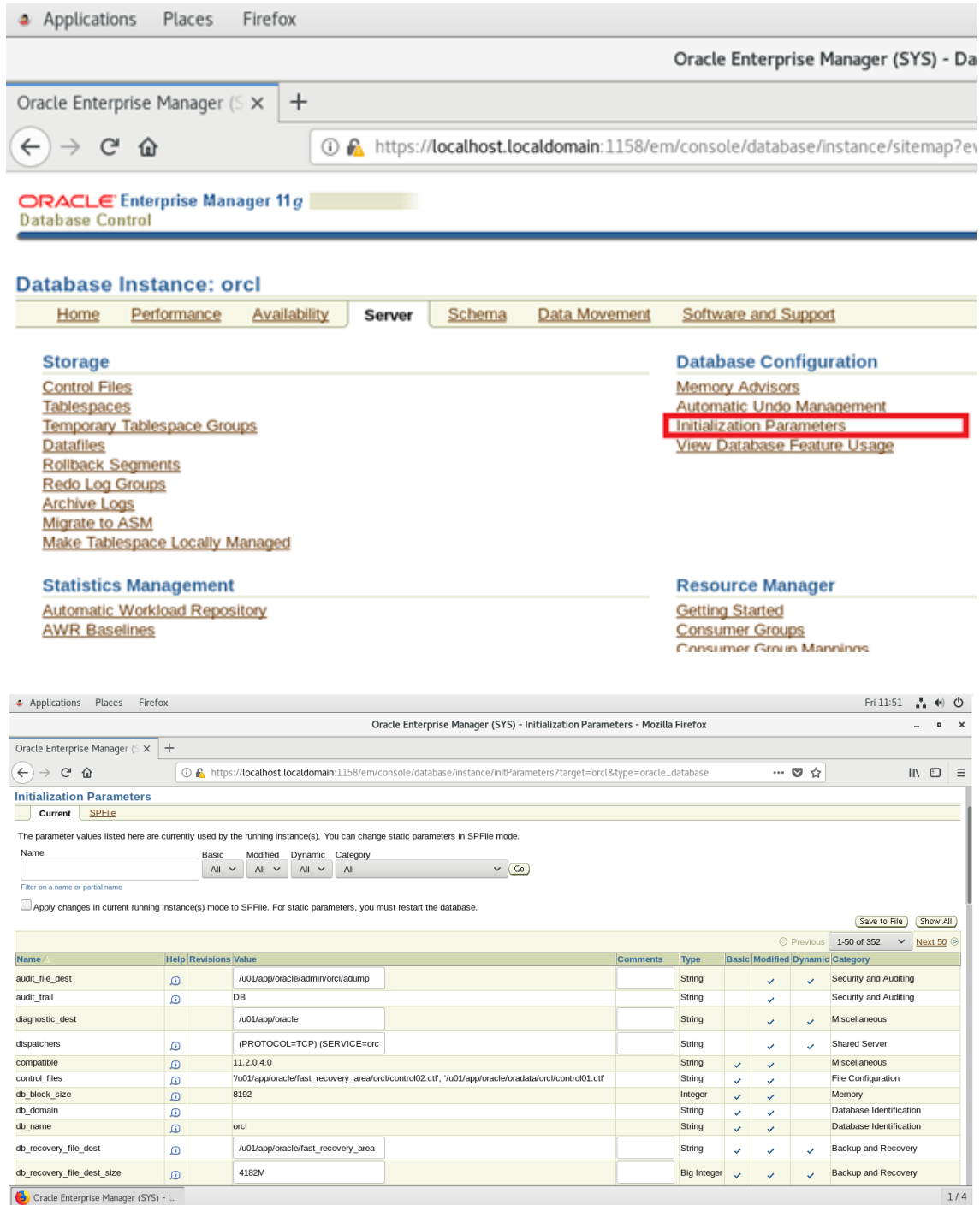

Fig. 13.6. Initialization parameters..

## **1.6. Memory component management.**

SGA and PGA must be maintained in optimal sizes, such as the requirements for changing memory usage.

In Oracle Database 11g, the Oracle Database server can automatically manage SGA and PGA memory through a capability called automatic memory management. The administrator specifies the total amount of memory that will be used by the instance, and the Oracle database server dynamically manages the amount of memory allocated to the Oracle instance's SGA and PGA. Automatic memory management is enabled by default when a major Oracle Database installation is performed. Oracle Corporation recommends the use of automatic memory management.

Automatic control of shared memory can be used for more control over the size of SGA components. The administrator sets a target and maximum size for the SGA. The Oracle Database server adjusts the size of the SGA components. Additionally, when Automatic Shared Memory Management is enabled, Automatic PGA Memory Management is implicitly enabled. The administrator sets the target size for PGA, for example, and the individual PGAs are set dynamically.

Manual shared memory management allows SGA dimensions to be managed by setting initialization parameters that determine the size of each component.

Note: When selecting a detailed installation of Oracle Database, select one of the three memory management modes.

### **Enable automatic memory management.**

If automatic memory management is not activated when Oracle Database is installed, it can be activated by following the steps below (fig. 13.7.):

1. Select "Memory Advisors" in the database configuration area of the "Server" page.
2. Select Enable - Enabled by default and must be turned off first.



Applications Places Firefox

Oracle Enterprise Manager (SYS) - Database Instance: orcl - Mozilla Firefox

Oracle Enterprise Manager (SYS) +

https://localhost.localdomain:1158/em/console/database/instance/sitemap?event=doLoad&target=orcl&type=oracle...

ORACLE Enterprise Manager 11g Database Control

Database Instance: orcl

Home Performance Availability Server Schema Data Movement Software and Support

Storage

- Control Files
- Tablespaces
- Temporary Tablespace Groups
- Datafiles
- Rollback Segments
- Redo Log Groups
- Archive Logs
- Migrate to ASM
- Make Tablespace Locally Managed

Database Configuration

- Memory Advisors
- Automatic Undo Management
- Initialization Parameters
- View Database Feature Usage

Database Instance: orcl > Advisor Central >

**Confirmation**

Automatic Memory Management has been successfully disabled.

**Memory Advisors**

When Automatic Memory Management is enabled, the database will automatically set the optimal distribution of memory. The distribution of memory will change

Automatic Memory Management Disabled

SGA PGA

The System Global Area (SGA) is a group of shared memory structures that contains data and control information for one Oracle database. The SGA is allocated

**Allocation History**

This chart shows the history of the components of the SGA.

Time	streams pool (MB)	Shared Pool (MB)	Buffer Cache (MB)	Java Pool (MB)	Large Pool (MB)
11:21	~5	~100	~150	~10	~5
11:25	~5	~100	~150	~10	~5
11:30	~5	~100	~150	~10	~5
11:35	~5	~100	~150	~10	~5
11:40	~5	~100	~150	~10	~5
11:45	~5	~100	~150	~10	~5
11:50	~5	~100	~150	~10	~5
11:55	~5	~100	~150	~10	~5
12:00	~5	~100	~150	~10	~5

Fig. 13.7. Automatic memory management - Memory Advisors.

3. The Enable Automatic Memory Management page appears. Specifies the total memory size for the database memory. Confirm with OK (fig. 13.8.).
4. A confirmation message is received.

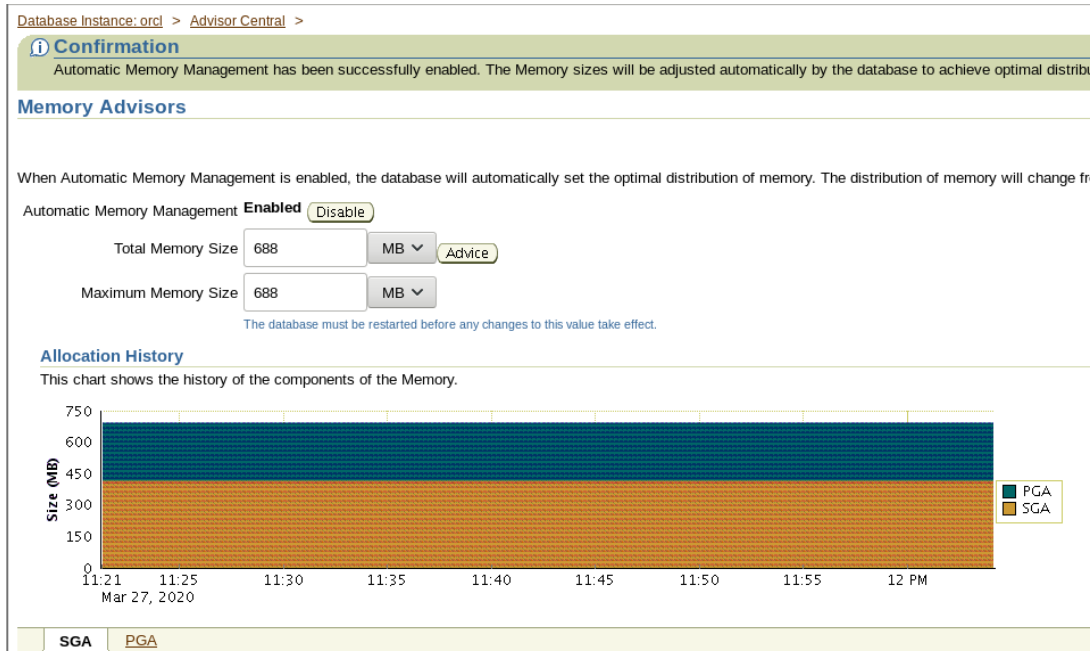

Fig. 13.8. Automatic memory management..

## Change memory settings: Automatically manage memory.

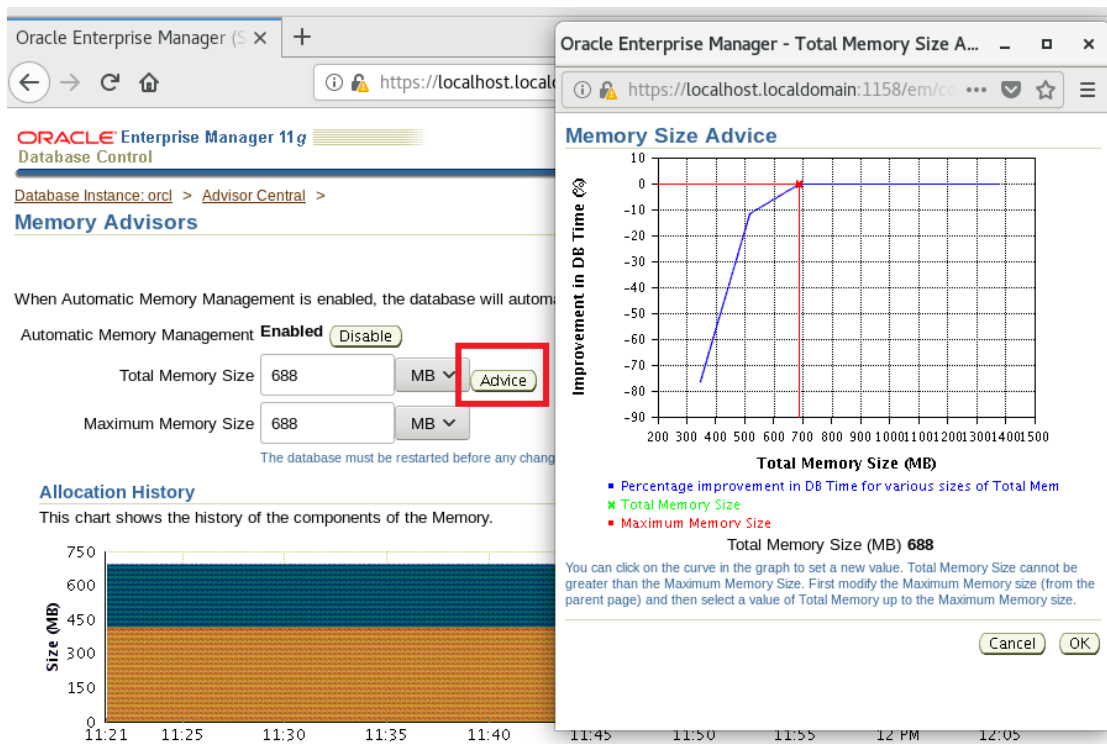

Fig. 13.9. Using Memory Advisors.

The Memory Advisors memory wizard is used to select a new memory setting (fig. 13.9.):

1. Select "Memory Advisors" in the database configuration area of the "Server" page.
2. Select "Advice".
3. The memory size tips page appears. A point on the curve is selected to set a new size and confirmed with OK.

Note: If you need to set a total memory size greater than the maximum memory size, you must first change the maximum memory size on the Memory Advisors page.

4. Select "Apply" on the "Memory Advisors" page.

### Enable automatic shared memory management.

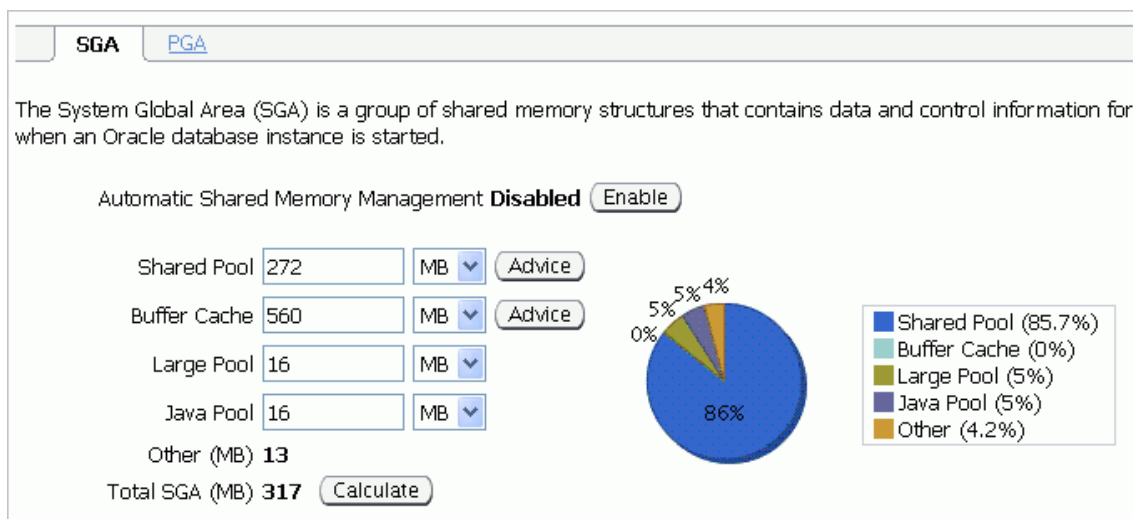

Fig. 13.10. Automatic management of shared memory.

Automatic shared memory management can be activated so that the Oracle server automatically resizes SGA components, including the shared pool and cache buffer (fig. 13.10.).

Activation of the automatic management of the shared memory is performed by performing the following steps:

1. Select "Memory Advisors" in the database configuration area of the "Server" page.
2. Scroll to the section "Automatic Shared memory Management" and select Enable / by default it is on and must first be turned off - only when needed / (fig. 13.11.).

3. The Enable Automatic Memory Sharing page appears. The total SGA size can be determined or the current SGA size can be accepted. Then confirm with OK.

You can increase the total SGA size later by increasing the value of the SGA\_TARGET initialization parameter.

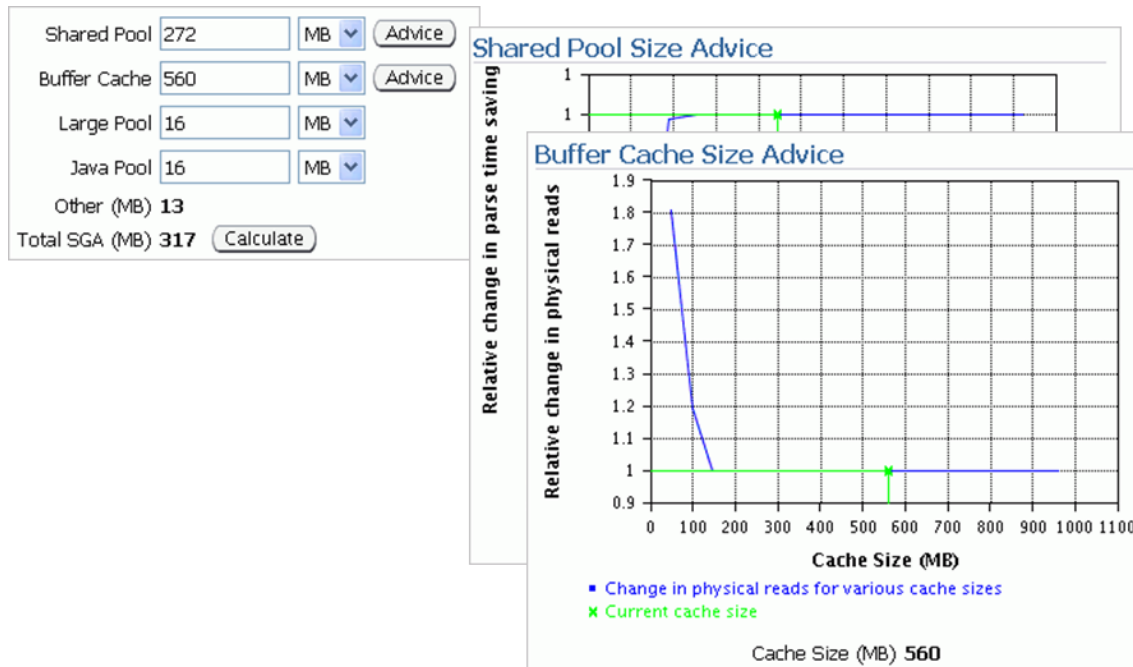

Fig. 13.11. Automatic SGA control.

### 1.7. Use shared memory management.

If you decide not to use automatic memory management or automatic shared memory management, each SGA component must be configured manually. When installing Oracle Database software and creating a user database, values are provided for the configuration of SGA components.

If the Oracle server reports a performance issue related to SGA or PGA size at a later time, memory wizards can be used to determine appropriate new settings..

## View the alert log.

Home | Performance | Availability | Server | Schema | Data Movement | Software and Support

**Related Links**

<a href="#">Access</a>	<a href="#">Add Exadata Cell Targets</a>	<a href="#">Advisor Central</a>
<a href="#">Alert History</a>	<a href="#">Alert Log Contents</a>	<a href="#">All Metrics</a>
<a href="#">Baseline Metric Thresholds</a>	<a href="#">Blackouts</a>	<a href="#">EM SQL History</a>
<a href="#">Jobs</a>	<a href="#">Metric and Policy Settings</a>	<a href="#">Metric Collection Errors</a>
<a href="#">Monitoring Configuration</a>	<a href="#">Monitor in Memory Access Mode</a>	<a href="#">Policy Groups</a>
<a href="#">Scheduler Central</a>	<a href="#">SQL Worksheet</a>	<a href="#">Target Properties</a>
<a href="#">User-Defined Metrics</a>		

Database | Setup | Preferences | Help | Logout

**ORACLE** Enterprise Manager 11g  
Database Control

Database Instance: orcl >

### View Alert Log Contents

**Log File Contents**

View Entries: Last 50 (dropdown) Go Search

Timestamp	Type	Level	Incid
(No data retrieved)			

Database | Setup | Preferences

Copyright © 1996, 2011 Oracle, JD Edwards, F... reserved.  
... are registered trademarks of Oracle Corporation and/or its affiliates. Other name:

About Oracle Ente...

Fig. 13.12. Alert log overview.

The Alert Log Contents is a file that contains a history log of messages and errors. The files of the warning log include the following (Fig. 13.12.):

- Record all internal errors (ORA-600), blocking conflict errors (ORA-1578) and blocking errors (ORA-60) that occur.
- Record administrative operations such as CREATE, ALTER and DROP statements and STARTUP, SHUTDOWN and ARCHIVELOG operations.
- Messages and errors related to shared server functions and dispatch processes.
- The value of all initialization parameters that had non-default values at the start point of the example.

The Oracle server records these operations in the alert log as an alternative to displaying information on the operator console. If the operation is successful, a "completed" message is recorded in the alert log, along with a timestamp.

Using Enterprise Manager, you can view the contents of the alert log by selecting Alert Log Contents in the linked links region of the database home page. Specify the number of records to view and select Go..